



PROFESSIONAL CLEANING EQUIPMENT

PROFESYONEL TEMİZLİK EKİPMANLARI



www.staffcleaningtrolley.com

www.staff.com.tr

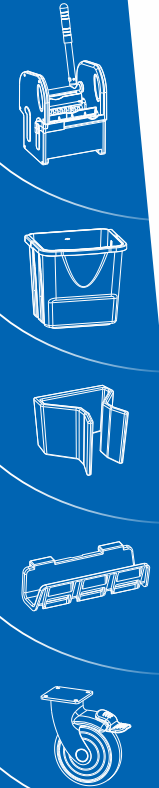



*Sayfalar
(Pages)*



**Temizlik Arabaları
(Cleaning Trolley) ----- 04 - 10**



**Housekeeping Arabaları
(Trolleys) ----- 11 - 20**



**Hastane Arabaları
(Medical Trolleys) ----- 21 - 22**



**Restaurant Servis Arabaları
(Restaurant Trolleys) ----- 23 - 27**



**Çöp Arabaları
(Waste Trolleys) ----- 28 - 29**



**Ekonomik Arabalar
(Economic Trolleys) ----- 30 - 35**

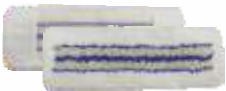

**Aksesuarlar
(Accessories) ----- 36 - 49**



**Aksesuarlar
(Accessories) ----- 50 - 60**



Kolay Temizleme Sistemleri
(Easy Clean)



OMNI 101

730 x 600 x 1140 mm



OMNI 109

730 x 600 x 1140 mm



OMNI 080

730 x 600 x 1140 mm



C 042 M01 eco

740 x 600 x 1050 mm



OMNI 104

700 x 600 x 1140 mm



OMNI 471M

1140 x 600 x 1080 mm



C 041 D

570 x 600 x 1250 mm



C 041 BTYCY

610 x 770 x 1200 mm



C 041 OD3BT2T2

570 x 600 x 1060 mm



C 041 MDN eco
750 X 600 X 1140 mm

C 111 MSK2BT1
980 X 600 X 1120 mm



C 111 MSBT2
980 X 600 X 1120 mm



C 111 MSD2
1080 X 600 X 1120 mm



C 111 SD2
980 X 600 X 1250 mm



C 111 D
980 X 600 X 1250 mm



C 111 SD2Y2
1200 X 600 X 1250 mm



C 111 0DK



C 270 D
920 X 600 X 1100 mm



C 270 DYC
920 X 600 X 1200 mm



C 270
920 X 600 X 1100 mm



C 270 YC
920 X 600 X 1200 mm



C 371
1480 X 600 X 1250 mm



C 241 D
960 X 600 X 1250 mm



C 451 MSK2
1480 X 600 X 1120 mm



C 451 MSDYBT2A3
1480 X 600 X 1120 mm



C 371 D
1480 X 600 X 1250 mm



C 371 0D7K
1480 X 600 X 1480 mm

**C 371 0**

1480 X 600 X 1100 mm

**C 451 SD2**

1380 X 600 X 1250 mm

**C 451 D**

1380 X 600 X 1250 mm

**C 451 DY**

1380 X 600 X 1250 mm

**C 451 MSD4T2 eco**

1480 X 600 X 1090 mm

**C 451 MR eco**

1480 X 600 X 1070 mm



C 451 MSK
1480 X 600 X 1120 mm



C 451 DKY
1380 X 600 X 1480 mm



C 451 S
1380 X 600 X 1250 mm



C 451 SD3
1380 X 600 X 1250 mm



C 451 S D2 Y
1380 X 600 X 1250 mm



C 451 S OD2
1380 X 600 X 1100 mm

**C 471 D**

1380 X 600 X 1250 MM

**C 471 MR eco**

1480 X 600 X 1070 mm

**H 1213 MVBTRW2**

1810 X 600 X 1455 mm

**H 1222 L2KW20D**

1880 X 600 X 1480 MM

**H 1222 SD4W**

1880 X 600 X 1250 MM

**H 1222 D4W2**

1880 X 600 X 1250 MM

**H 1542 OSDT3BT**

1880 X 600 X 1100 mm

**H 1222 LW2**

1880 X 600 X 1250 mm

**H 1222 0LKW2**

1880 X 600 X 1480 mm

**H 1222 SD2W2**

1880 X 600 X 1250 mm

**N 451 MS01**

1600 X 600 X 1100 mm

**M 1104 ODYO eco**

1810 X 600 X 1260 mm



H 1502 D
1880 X 600 X 1250 mm



H 1504 D
1880 X 600 X 1250 mm



H 1502 0D
1880 X 600 X 1100 mm



H 1502 0DA
1880 X 600 X 1080 mm



H 1521 SWD3
1880 X 600 X 1250 mm



H 2222 D4W
1880 X 600 X 1250 mm



H 501 0LKW2
1060 X 600 X 1480 mm



H 502 0DL2K
1060 X 600 X 1480 mm



H 501 0WD3
950 X 600 X 1060 mm



H 514 D3
1060 X 600 X 1250 mm



H 2222 D4
1880 X 600 X 1250 mm



H 2222 D2
1880 X 600 X 1250 mm



H 1561 0L2K
1880 X 600 X 1480 mm



H 1561 0K
1880 X 600 X 1480 mm



H 1561 L
1880 X 600 X 1250 mm



H 1561
1880 X 600 X 1250 mm



H 1561 0L
1880 X 600 X 1100 mm



H 1561 0
1880 X 600 X 1100 mm



H 551 0L
1060 X 600 X 1050 mm



H 551 0
1060 X 600 X 1050 mm



H 551 Y
1170 X 600 X 1250 mm



H 551 LY
1170 X 600 X 1250 mm



H 1102 0
1360 X 600 X 1100 mm



H 501 0R2W2K
1060 X 600 X 1480 mm



H 1102 D
1360 X 600 X 1250 mm

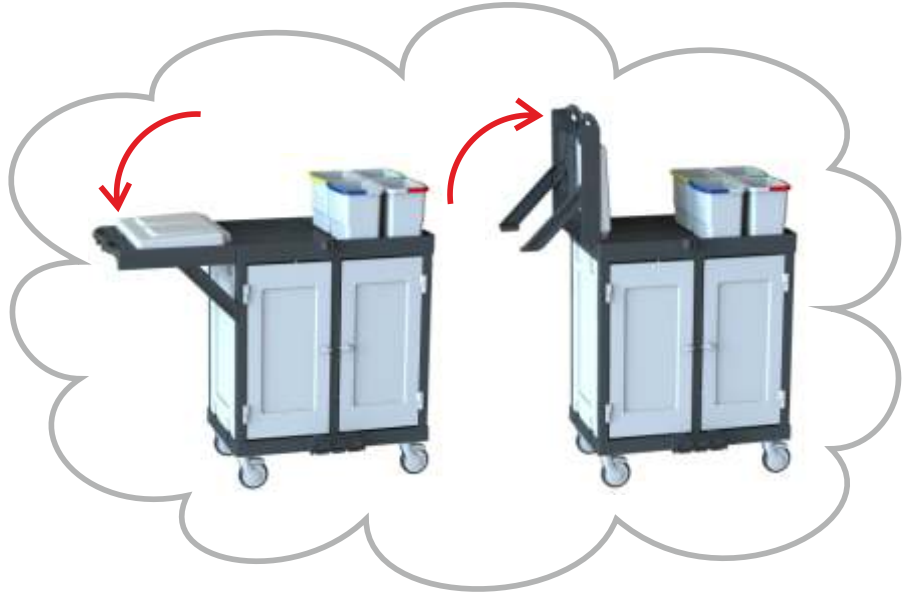

H 1102
1360 X 600 X 1250 mm



H 1201 0WD3Y20
1580 X 600 X 1100 mm



H 1251
1360 X 600 X 1250 mm



H 1251 L
1360 X 600 X 1250 mm



H 1251 0K
1360 X 600 X 1480 mm



H 1251 0L2K
1360 X 600 X 1480 mm



H 1202 OSD2
1460 X 600 X 1100 mm



H 1202 0D
1360 X 600 X 1100 mm



H 502 D
1060 X 600 X 1250 mm



H 502 W
1060 X 600 X 1250 mm



H 1201 0L2K
1360 X 600 X 1480 mm



H 502 D3
1060 X 600 X 1250 mm



H 1201 0L2KD
1360 X 600 X 1480 mm



H 1201 0LK
1360 X 600 X 1480 mm



CTB150
460 X 510 X 950 mm



CTB 600
1770 X 600 X 950 mm



CTK300
850 X 510 X 950 mm



CTB 450
1310 X 600 X 950 mm



CTK502D3
1770 X 600 X 950 mm



CTB502D3
1770 X 600 X 950 mm



M 041 B2DY

800 X 600 X 1250 mm



M 041 B2D3

570 X 600 X 1250 mm



M 090 D

510 X 600 X 1100 mm



M 111 SD2

980 X 600 X 1250 mm



M 090

510 X 600 X 1100 mm



M 090 Y

750 X 600 X 1200 mm



M 111

980 X 600 X 1250 mm



M 451 S D2Y

1380 X 600 X 1250 mm



M 111 Y2
1200 X 600 X 1250 mm



M 111 SD
980 X 600 X 1250 mm



M 111 DY2
1200 X 600 X 1250 mm



M 111 D
980 X 600 X 1250 mm



M 111 D3Y
1200 X 600 X 1250 mm



M 111 DY
1200 X 600 X 1250 mm



R 1122 SWD
1360 X 600 X 1250 mm



R 1122 W
1360 X 600 X 1250 mm



R 1214 D3
1460 X 600 X 1250 mm



R 1122 WD3
1360 X 600 X 1250 mm



R 1202 S
1460 X 600 X 1250 mm



R 1202 SD5
1360 X 600 X 1250 mm



R 1202 SD2
1460 X 600 X 1250 mm



R 1202 SD4BT
1460 X 600 X 1250 mm



R 1202 SD4
1460 X 600 X 1250 mm



R 1202 SD3BT
1460 X 600 X 1250 mm



R 1202 MSD2BT2H3
1450 X 600 X 1120 mm



R 1103 OD3BT9
1500 X 600 X 1050 mm



R 1202 MSDBT4
1450 X 600 X 1120 mm



R 1103 M3W1BT4
1550 X 600 X 1120 mm



R 1551 D
1480 X 600 X 1250 mm



R 1551 W
1480 X 600 X 1250 mm



R 1551 WD
1480 X 600 X 1250 mm



R 1551 WD3
1480 X 600 X 1250 mm



R 1551
1480 X 600 X 1250 mm



R 1551 D3
1480 X 600 X 1250 mm



R 1551 BT2
1460 X 600 X 1100 mm



R 1551 W1
1460 X 600 X 1100 mm



R 1202 SD
1460 X 600 X 1250 mm



R 1551 D7
1460 X 600 X 1250 mm



R 1203 TOD3 BT3
1910 X 600 X 1250 MM



R 1203 D
1910 X 600 X 1250 MM



R 1103 D
1500 X 600 X 1250 MM



R 1103 TOD3 BT3
1500 X 600 X 1250 MM



R 1103 TOD BT3
1500 X 600 X 1250 MM



W 092



W 090 D YCY
760 X 600 X 1200 MM



W 090 D
510 X 600 X 1100 MM



W 090
510 X 600 X 1100 MM



W 099 D
1020 X 540 X 1100 mm

W 390 D
1620 X 540 X 1100 mm



W 099
1020 X 540 X 1100 mm

W 390
1550 X 540 X 1100 mm



C 041 eco
570 X 600 X 1220 mm



C 041 OR eco
570 X 600 X 1020 mm



C 111 R eco
980 X 600 X 1220 mm



C 111 BTR2 eco
980 X 600 X 1220 mm



C 111 ORY20 eco
1180 X 600 X 1080 mm



C 111 MR eco
980 X 600 X 1070 mm



C 111 SD2 eco
980 X 600 X 1220 mm



C 111 D eco
980 X 600 X 1220 mm



C 111 SY2BT eco
1180 X 600 X 1220 mm



C 270 YC eco
920 X 600 X 1170 mm



C 270 Y0 eco
920 X 600 X 1080 mm



C 270 eco
920 X 600 X 1080 mm



C 270 DYC eco
920 X 600 X 1170 mm



C 270 DTBYC eco
920 X 600 X 1170 mm



C 270 TBYC eco
920 X 600 X 1170 mm



C 241 D eco
960 X 600 X 1220 mm



C 241 R eco
960 X 600 X 1220 mm



C 471 eco
1380 X 600 X 1220 mm



C 471 R eco
1380 X 600 X 1220 mm



C 371 eco
1480 X 600 X 1220 mm



C 371 R eco
1480 X 600 X 1220 mm



C 451 1R eco
1380 X 600 X 1220 mm



C 451 R eco
1380 X 600 X 1220 mm



C 451 D eco
1380 X 600 X 1220 mm



R 1102 R eco
1360 X 600 X 1220 mm



H 1502 R eco
1870 X 600 X 1220 mm



H 1521 SWR eco
1870 X 600 X 1220 mm



H 1561 0L eco
1870 X 600 X 1100 mm



H 1561 0 eco
1870 X 600 X 1100 mm



C 551 eco
1060 X 520 X 910 mm



H 501 WR eco
1060 X 600 X 1220 mm



H 501 SWR eco
1060 X 600 X 1220 mm



H 500 Y20 eco
1190 X 530 X 1070 mm



H 502 R eco
1060 X 600 X 1220 mm



H 502 eco
1060 X 600 X 1220 mm



H 1251 L eco
1360 X 600 X 1100 mm



W 099 eco
1020 X 540 X 1080 mm



W 090 eco
510 X 600 X 1080 mm



PA4010209

(4 Renk) Temizlik Kovası (8 Lt)



PB4000009

Temizlik Kovası (20 Lt) (Mavi)



PB4000010

Temizlik Kovası (20 Lt) (Kırmızı)



PB4010309

Temizlik Kovasi (5 Lt)



PB4010309

5 Lt lik Temizlik Kovasi Süzgeçi



PA40102091

8 Lt lik kova kapağı



PB4000011

Büyük Tepsi



PB4000012

Derin Tepsi Kapağı



W01132K

Mop Kovası (Geniş) (Kırmızı)



W01132M

Mop Kovası (Geniş) (Mavi)



W01133K

Mop Kovası (dar) (Kırmızı)



W01133M

Mop Kovası (dar) (Mavi)



PA4010210

Plastik Sepet



Pb4010211

Omni Çöp Üst Gövde

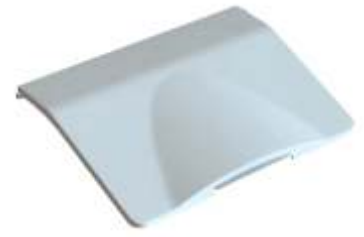

Pb4010212

Omni Çöp Üst kapak



PA4010220

Torba Asma Kancası



PA4010222

Aksesuar Adaptörü



PA40102221

Aksesuar Adaptör (Çöp için)



PA4010211

Torba kelepçe takımı



PA4010213

Torba Seperatör



PA4010227

Temizlik Araba İtme Sapı



PA4010211K

Torba Kelepçe Takımı (Kısa)



PA4010213K

Torba Seperatör (Kısa)



PA4010210A

Bağlantı Aparatı



PA4010206

Çöp Üst Gövde Hareketli



PA4010206P

Çöp Üst Gövde Pimi
90 mm

PA4010243

Çöp Üst Gövde Sabit



PA4010207

Dirsek Sabitleme takımı



PA4010207P

Dirsek Sabitleme Pimi
27 mm

PA4010216

Mop Sap Tutucu



PA4020003

Pres Ayağı



PA4020003A

Pres Ayağı



PA4010215

Mop Altlığı



Pb4010214

İş Programlı Üst Kapak



Pb4010213

Küçük Araba Gömmeli Üst



Pb4010311

Tabldot



PA40102022

Büyük Araba Üst Gövde (Çift Hareketli)

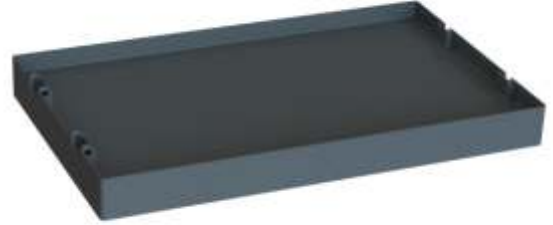

PA40102020

Büyük Araba Üst Gövde (Tek Hareketli)



PA4010203

Küçük Araba Alt Gövde



PA4010204

Küçük Araba Üst Gövde



PA4000001

Raf Ahşap (Küçük)



PB4000014

Tepsi Raf Takımı



PB4000013

Çamaşır Araba Plastik Köşe



PA4010201

Büyük Araba Orta Gövde



PA4000003

Raf Ahşap (Büyük)

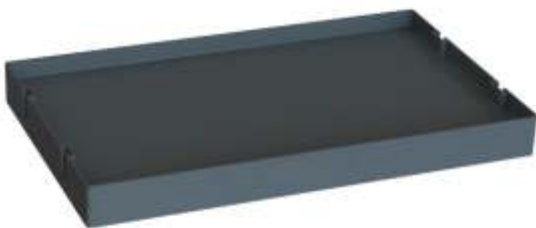

PA4010202

Büyük Araba Üst Gövde



PA4010201

Büyük Araba Alt Gövde



PA4010208

Çöp Kapak



PA4010208P

Çöp Kapak Pimi
56 mm

PA4010208D

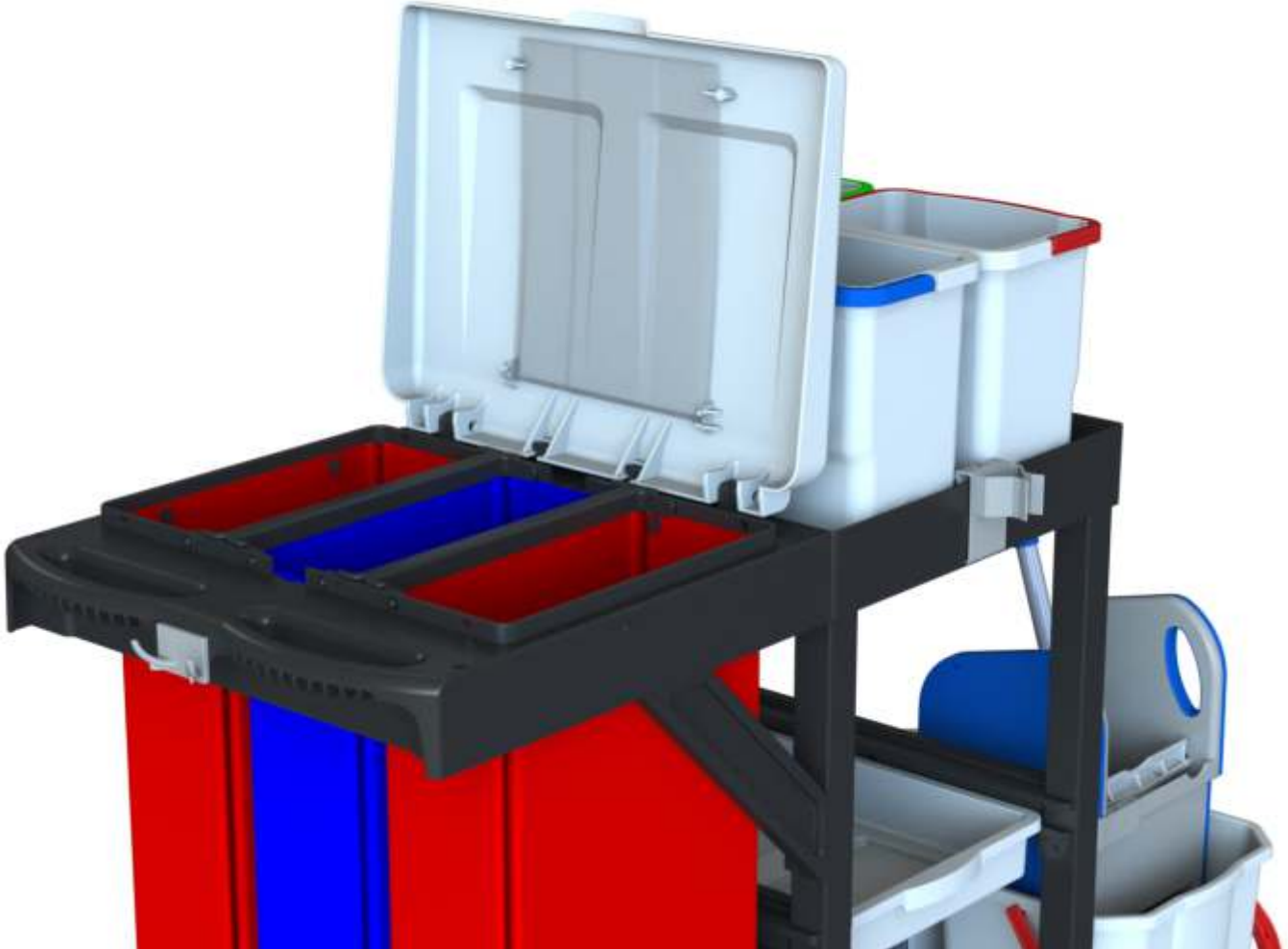
İş program dosyalık+
Çöp kapak dosyalık Kiliti



4010238KP

Dolap Kapak Kilit Plastik



PA4010218

Dolap Kapak Kilit Metal

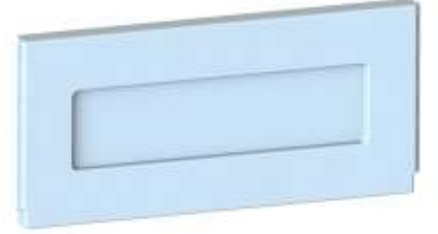

Pa4010242

Yatay Arka Duvar



PA4010239

Dolap Kapak (Sol)



PA4010238

Dolap Kapak (Sağ)

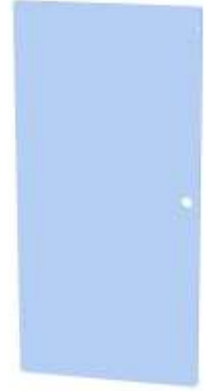

Pb4010315

Kompozit Ön Kapak



PA4010237-1

Yan Kapak (İç)



PA4010237-2

Yan Kapak (Dış)



Pa4010240

Sapit Ön Duvar



Pb4010314

Dispenser Montaj Aparatı



Pb4010313

Dispenser



PA4010212

Plastik Tepsi

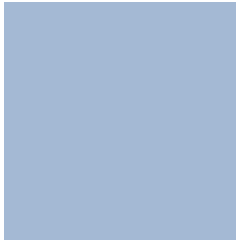

KU 370X378

Kompozit Duvarı



Pa4010241

Küçük Yan Duvar



KYA 430X764

Kompozit Duvarı

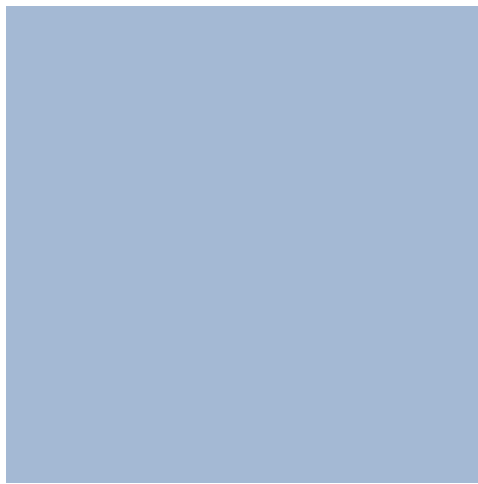

KAB 768X764

Kompozit Duvarı

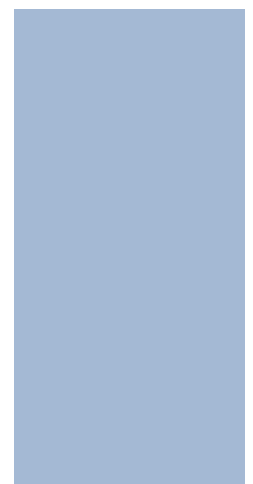

KA 368X764

Kompozit Duvarı

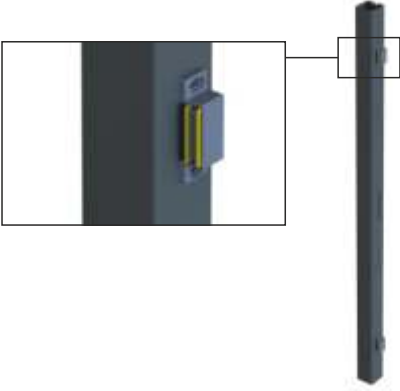

PA4010205MT

Plastik Direk (85 cm)
Mıknatıslı (tek taraf)

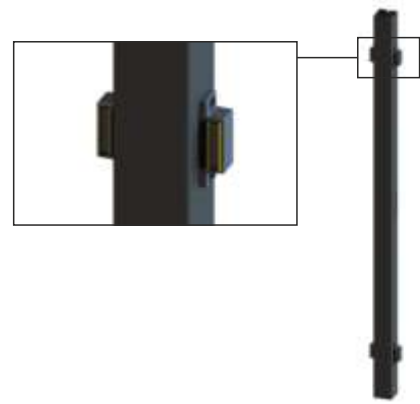

PA4010205MC

Plastik Direk (85 cm)
Mıknatıslı (Çift taraf)



PA4010205A

Alüminyum Direk (85 cm)



PA4010205

Plastik Direk (85 cm)



PA4010205K

Plastik Direk (42 cm)



PA4010239M

Menteşe (Sol)



PA4010238M

Menteşe (Sağ)



PA4010205AK

Alüminyum Direk (42 cm)



PA4072005K

Torba Brandası 120Lt (Kırmızı)



PA4072005M

Torba Brandası 120Lt (Mavi)



PA4072006K

Torba Brandası 50Lt (Kırmızı)



PA4072006M

Torba Brandası 50Lt (Mavi)



PA4072001

Torba Brandası 120Lt (Fermuarlı)



PA4072005KK

Torba Brandası 60Lt (Kırmızı)



PA4072005MK

Torba Brandası 60Lt (Mavi)



AO38
Busy Double



AO37
Busy Double (Tekersiz)



H00150
Su Hortumu



AO39
Busy Double (Yanaklı Presli)



PA4010219
Yanaklı Pres



PA4010225G
Dik Pres



AO40
Busy Bucket (Dik Presli)



PA4010225B
Dik Pres



PA4010225
Dik Pres



AO32

Paspas Arabası (Büyük)



AO30

Paspas Arabası



AO02

İkaz Levhası



AO03

İkaz Levhası



Tutucu Askılık / Holders Hanger

SA5000

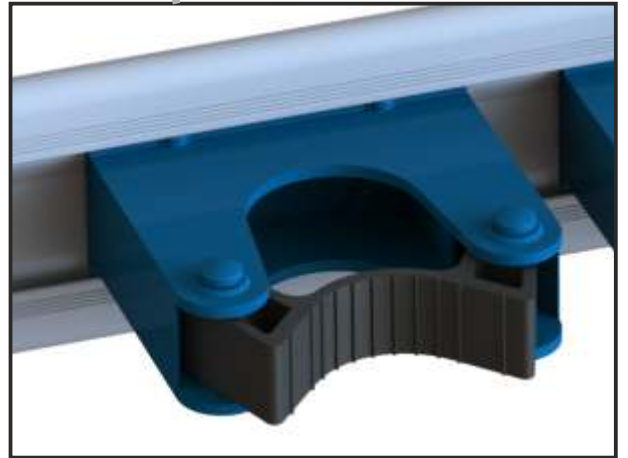
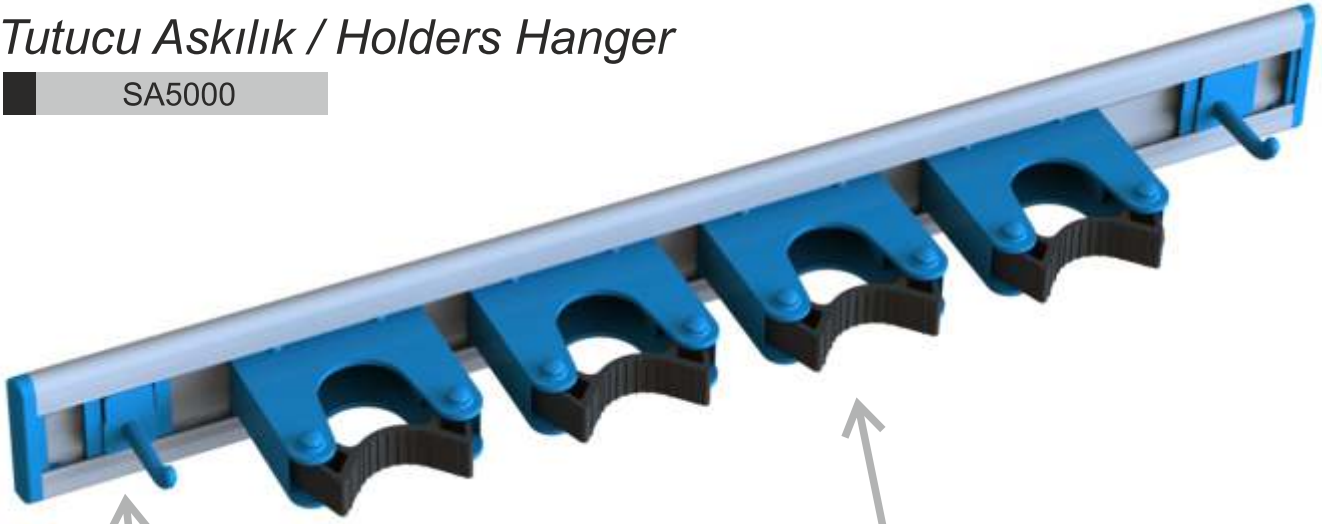

SA5001



SA5004



SA5003



SA5002



SA5005



SA5006





MED- BLUE

MICROFIBRE YARN COVER

THE MICROFIBRE YARN COVER
WITH HIGH FILAMENT CONTENT!

MADE IN EEC

SPECIFICATIONS

Yarn mixture:	100% polyester, with high filament content	
Yarn colour:	BLUE-WHITE	
Cover sheet:	50% fine cotton and 50% polyester	
Edging tape:	100% polyester, WHITE	
Bag material:	100% polyester	
Shrinkage value:	2-3%	
Washing label:	Embroidery label in WHITE, embroidered on 2 sides	
4-colour coding:	BLUE, GREEN, YELLOW, RED	

Measurements:	40 cm	50 cm
Weight:	ca. 130 g	ca. 160 g

UNITS:	75 pcs.	50 pcs.
article-no.:	MEDBLUE40	MEDBLUE50

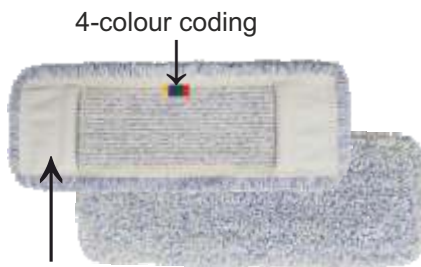

Bag material made of
100% polyester with inserts
tear resistant & water permeable



Do not use fabric softener
Wash according to type



SPECIAL FEATURES

The top sheet is made of 50% fine cotton and 50% polyester

To enable optimum absorbency of the cover this mixing ratio is recommended.

The bags' material is made of 100% woven polyester and reinforced with a sponge insert to help the holder slide.

The high-quality microfibre content and the composition of the top sheet guarantee perfect dirt and water absorption as well as optimal gliding properties.

Due to the high proportion of filaments, a very high area performance as well as an optimal cross-linking of cleaning and disinfecting agents is achieved.

PROPERTIES

The microfibre yarn cover offers an above-average service life due to its special tufting process, whereby the loops are firmly anchored in the cover sheet. The mop cover convinces with excellent gliding properties and high dirt and water absorption. water absorption.

- High surface performance and excellent cross-linking of cleaning and disinfecting agents thanks to the high proportion of filaments → Continuous fibres
- Ideal dirt and water absorption
- Very good gliding properties for fatigue-free work
- Tear-resistant and water-permeable polyester pockets
- Long service life due to high-quality manufacturing process

APPLICATION

Can be used both dry and wet on smooth, coated and uncoated floor coverings.

APPLICATION AREA

For maintenance cleaning, as well as for wet and dry cleaning of any surfaces, such as elastic coverings, hard coverings, porcelain stoneware, stone floors, tiles, laminate floors and ideally suited for smooth and porous floor coverings. Particularly suitable for use in health care, clinics, retirement and nursing homes as well as public facilities and building cleaning.

WASHING RECOMMENDATION

A washing temperature of 60 °C is recommended. A maximum washing temperature of 95 °C should not be exceeded. The use of fabric softeners and bleaching agents should be avoided. In general, it is recommended to wash only unmixed fabrics.

Do not exceed 80 °C when drying.



MED- RED

MICROFIBRE YARN COVER

THE MICROFIBRE YARN COVER
WITH HIGH FILAMENT CONTENT!

MADE IN EEC



Special
Cover 50/50

4-colour coding

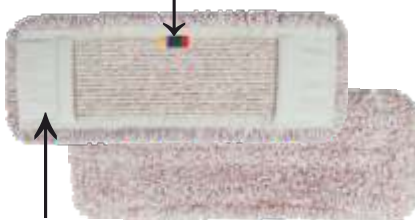

Bag material made of
100% polyester with inserts
tear resistant & water permeable



Do not use fabric softener
Wash according to type



SPECIFICATIONS

Yarn mixture:	100% polyester, with high filament content	
Yarn colour:	RED-WHITE	
Cover sheet:	50% fine cotton and 50% polyester	
Edging tape:	100% polyester, WHITE	
Bag material:	100% polyester	
Shrinkage value:	2-3%	
Washing label:	Embroidery label in WHITE, embroidered on 2 sides	
4-colour coding:	BLUE, GREEN, YELLOW, RED	

Measurements:	40 cm	50 cm
Weight:	ca. 130 g	ca. 160 g

UNITS:	75 pcs.	50 pcs.
article-no.:	MEDRED40	MEDRED50



SPECIAL FEATURES

The top sheet is made of 50% fine cotton and 50% polyester

To enable optimum absorbency of the cover this mixing ratio is recommended.

The bags' material is made of 100% woven polyester and reinforced with a sponge insert to help the holder slide.

The high-quality microfibre content and the composition of the top sheet guarantee perfect dirt and water absorption as well as optimal gliding properties.

Due to the high proportion of filaments, a very high area performance as well as an optimal cross-linking of cleaning and disinfecting agents is achieved.

PROPERTIES

The microfibre yarn cover offers an above-average service life due to its special tufting process, whereby the loops are firmly anchored in the cover sheet. The mop cover convinces with excellent gliding properties and high dirt and water absorption. water absorption.

- High surface performance and excellent cross-linking of cleaning and disinfecting agents thanks to the high proportion of filaments → Continuous fibres
- Ideal dirt and water absorption
- Very good gliding properties for fatigue-free work
- Tear-resistant and water-permeable polyester pockets
- Long service life due to high-quality manufacturing process

APPLICATION

Can be used both dry and wet on smooth, coated and uncoated floor coverings.

APPLICATION AREA

For maintenance cleaning, as well as for wet and dry cleaning of any surfaces, such as elastic coverings, hard coverings, porcelain stoneware, stone floors, tiles, laminate floors and ideally suited for smooth and porous floor coverings. Particularly suitable for use in health care, clinics, retirement and nursing homes as well as public facilities and building cleaning.

WASHING RECOMMENDATION

A washing temperature of 60 °C is recommended. A maximum washing temperature of 95 °C should not be exceeded. The use of fabric softeners and bleaching agents should be avoided. In general, it is recommended to wash only unmixed fabrics.

Do not exceed 80 °C when drying.



HYGIENIC DURITIA

BRISTLE MICROFIBRE COVER

THE MICROFIBRE YARN COVER
WITH HIGH FILAMENT CONTENT!

MADE IN EEC

SPECIFICATIONS

Yarn mixture:	70% polyester, 30% polyamide	
Fabric back:	Coated and fixed	
Bag material:	100% polyester	
Colour:	WHITE - DARK BLUE	
Shrinkage value:	2-3%	
Washing label:	British Satin Label in WHITE, embroidered on 2 sides	

Measurements:	40 cm	50 cm
Weight:	ca. 81 g	ca. 104 g

UNITS:	75 pcs.	50 pcs.
article-no.:	HD40	HD50



Polyamide bristle strips

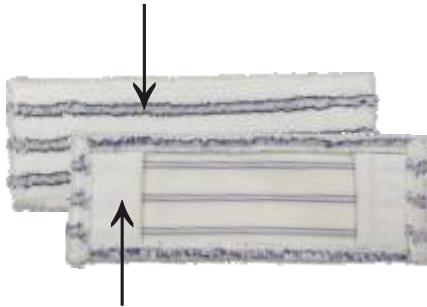

Bag material made of
100% polyester with inserts
tear resistant & water permeable



Do not use fabric softener
Wash according to type



SPECIAL FEATURES

The bag material is made of 100% woven polyester and reinforced with a sponge insert to support the gliding of the holder. The special polyamide bristle strips not only provide excellent gliding properties, but also an optimum dirt loosening power and pore-deep cleaning due to the generating mechanics.

PROPERTIES

The bristle microfibre cover has excellent gliding properties due to the polyamide bristle strips and is ideal against firmly adhering dirt. At the same time, the dirt and water absorption are optimal.

- High water absorption and water depot effect
- High quality plush microfibre
- Very good gliding properties for fatigue-free work
- Tear resistant and water permeable polyester pockets
- Light scrubbing effect for dirt and stain removal

APPLICATION

Can be used both dry and wet on smooth, coated and uncoated floor coverings.

APPLICATION AREA

For maintenance cleaning, deep cleaning as well as wet and dry cleaning of any surfaces, such as elastic coverings, hard coverings, porcelain stoneware, stone floors, tiles, laminate floors, sealed parquet (Use only damp or dry) and ideally suited for smooth and porous floor coverings. Particularly suitable for use in industry, production, healthcare, clinics, retirement and nursing homes as well as for public facilities and building cleaning. Translated with www.DeepL.com/Translator (free version)

WASHING RECOMMENDATION

A washing temperature of 60 °C is recommended. A maximum washing temperature of 90 °C should not be exceeded. The use of fabric softeners and bleaching agents should be avoided. In general, it is recommended to wash only unmixed fabrics. Do not exceed 80 °C when drying.



HYGIENIC MOLLIS

MICROFIBRE COVER

THE MICROFIBRE YARN COVER
WITH HIGH FILAMENT CONTENT!

MADE IN EEC



SPECIFICATIONS

Yarn mixture:	100% polyester	
Colour:	WHITE	
Fabric back:	Coated and fixed	
Bag material:	100% polyester	
Shrinkage value:	2-3%	
Washing label:	British Satin Label in WHITE, embroidered on 2 sides	

Measurements:	40 cm	50 cm
Weight:	ca. 74 g	ca. 100 g

UNITS:	75 pcs.	50 pcs.
article-no.:	HM40	HM50

Overlock stitching in WHITE

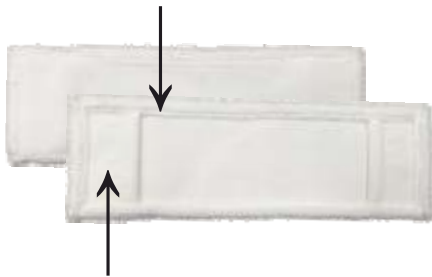

Bag material made of
100% polyester with inserts
tear resistant & water permeable



SPECIAL FEATURES

The bag material is made of 100% woven polyester and reinforced with a sponge insert to help the holder glide.

PROPERTIES

Due to its fibre, the microfibre cover has an electrostatic effect and is therefore ideal for dust-binding dry cleaning. Due to its good cleaning results, the chemical use can be reduced. At the same time, the dirt and water absorption are optimal.

- High water absorption and water depot effect
- High quality plush microfibre
- Tear resistant and water permeable polyester pockets
- Long service life due to high-quality manufacturing process

APPLICATION

Can be used both dry and wet on smooth, coated and uncoated floor coverings.

APPLICATION AREA

For maintenance cleaning, deep cleaning as well as wet and dry cleaning of any surfaces, such as elastic coverings, hard coverings, porcelain stoneware, stone floors, tiles, laminate floors and ideally suited for smooth and porous floor coverings. Particularly suitable for use in industry, production, healthcare, clinics, retirement and nursing homes and public facilities and building cleaning.

WASHING RECOMMENDATION

A washing temperature of 60 °C is recommended. A maximum washing temperature of 90 °C should not be exceeded. The use of fabric softeners and bleaching agents should be avoided. In general, it is recommended to wash only unmixed fabrics. Do not exceed 80 °C when drying.



Do not use fabric softener
Wash according to type





LOOPY

MICROFIBRE LOOP COVER

THE MICROFIBRE YARN COVER
WITH HIGH FILAMENT CONTENT!

MADE IN EEC



SPECIFICATIONS

Yarn mixture:	100% polyester	
Colour:	WHITE	
Fabric back:	Coated and fixed	
Edging tape:	100% polyester, WHITE	
Bag material:	100% polyester	
Shrinkage value:	2-3%	
Washing label:	Embroidery label in WHITE, embroidered on 2 sides	
4-colour coding:	BLUE, GREEN, YELLOW, RED	

Measurements:	40 cm	50 cm
Weight:	ca. 104 g	ca. 125 g

UNITS:	75 pcs.	50 pcs.
article-no.:	L40	L50

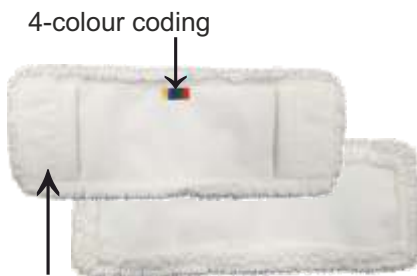

Bag material made of
100% polyester with inserts
tear resistant & water permeable



SPECIAL FEATURES

The bag material is made of 100% woven polyester and reinforced with a sponge insert to help the holder glide.

PROPERTIES

Due to its fibre, the microfibre loop cover has an electrostatic effect and is therefore ideal for dust-binding dry cleaning. Due to its excellent cleaning results, chemical use can be reduced. At the same time, the dirt and water absorption are optimal. As a result of the closed outer fringes made of polyester microfibre, hygienic cleaning is achieved.

- Optimal dirt and water absorption due to loops of polyester microfibre
- High water absorption and water depot effect
- High quality plush microfibre
- Tear-resistant and water-permeable polyester pockets
- Long service life due to high-quality manufacturing process and special yarns

APPLICATION

Can be used both dry and wet on smooth, coated and uncoated floor coverings.

APPLICATION AREA

For maintenance cleaning, deep cleaning as well as wet and dry cleaning of any surfaces, such as elastic coverings, hard coverings, porcelain stoneware, stone floors, tiles, laminate floors and ideally suited for smooth and porous floor coverings.

Particularly suitable for use in industry, production, healthcare, clinics, retirement and nursing homes and public facilities and building cleaning.

WASHING RECOMMENDATION

A washing temperature of 60 °C is recommended. A maximum washing temperature of 95 °C should not be exceeded. The use of fabric softeners and bleaching agents should be avoided. In general, it is recommended to wash only unmixed fabrics. Do not exceed 80 °C when drying.



Do not use fabric softener
Wash according to type





LOCUS TALL

MIXED COVER

THE MICROFIBRE YARN COVER
WITH HIGH FILAMENT CONTENT!

MADE IN EEC



SPECIFICATIONS

Yarn mixture:	75% CO/PES yarn, NATUR E 20% polyester microfibre, WHITE 5% CO/PES STRIPES, GREEN	
Yarn colour:	NATURE-WHITE-GREEN	
Cover sheet:	50% fine cotton and 50% polyester	
Edging tape:	100% polyester, GREEN	
Bag material:	100% polyester	
Shrinkage value:	3-4%	
Washing label:	British Satin Label in WHITE, embroidered on 2 sides	
Measurements:	40 cm	50 cm
Weight:	ca. 140 g	ca. 180 g
UNITS:	75 pcs.	50 pcs.
article-no.:	LT40	LT50

CO/PES-Stripes in GREEN



SPECIAL FEATURES

The cover sheet is made of 50% fine cotton and 50% polyester. To allow optimal cover absorbency, this mixture ratio is recommended. Many market competitors produce this cover sheet from 100% polyester. The bag material is made of 100% woven polyester and reinforced with a sponge insert to help the holder slide.

PROPERTIES

The mixed yarn cover offers an above-average service life due to its special tufting process, whereby the loops are firmly anchored in the cover sheet. The mop cover convinces with very good gliding properties and high dirt and water absorption.

- Optimal dirt and water absorption
- The economical solution
- Very good gliding properties for fatigue-free work
- Tear resistant and water permeable polyester pockets
- Long service life due to high-quality manufacturing process

APPLICATION

Can be used both dry and wet on smooth, coated and uncoated floor coverings.

APPLICATION AREA

For maintenance cleaning of any surfaces, such as elastic coverings, hard coverings, porcelain stoneware, stone floors, tiles, laminate floors and ideally suited for smooth floor coverings. The mop cover is ideal for use in all areas due to the high quality yarn fibres (cotton, polyester, polyester microfibre) and cleans even heavily soiled floor coverings effortlessly.

WASHING RECOMMENDATION

A washing temperature of 60 °C is recommended. A maximum washing temperature of 90 °C should not be exceeded. The use of fabric softeners and bleaching agents should be avoided. In general, it is recommended to wash only unmixed fabrics. Do not exceed 80 °C when drying.



Do not use fabric softener
Wash according to type





LOCUS GRANDE

HYGIENE MIXED YARN COVER

THE MICROFIBRE YARN COVER WITH HIGH FILAMENT CONTENT!



MADE IN EEC

SPECIFICATIONS

Yarn mixture:	60% CO/PES yarn, NATURE 30% polyester microfibre, WHITE 10% CO/PES stripes, BLUE	
Yarn colour:	NATURE-WHITE-BLUE	
Cover sheet:	50% fine cotton and 50% polyester	
Edging tape:	100% polyester, BLUE	
Bag material:	100% polyester	
Shrinkage value:	3-4%	
Washing label:	Embroidery label in WHITE, embroidered on 2 sides	
4-colour coding:	BLUE, GREEN, YELLOW, RED	
Measurements:	40 cm	50 cm
Weight:	ca. 160 g	ca. 200 g
UNITS:	75 pcs.	50 pcs.
article-no.:	LG40	LG50

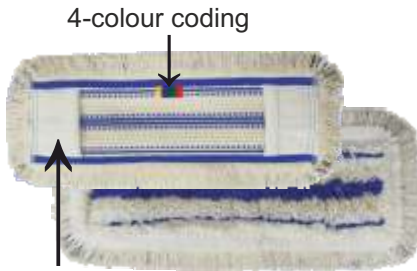
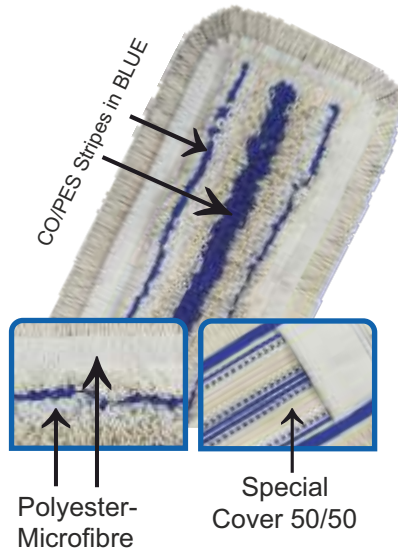

Bag material made of 100% polyester with inserts tear resistant & water permeable



Do not use fabric softener
Wash according to type



SPECIAL FEATURES

The top sheet is made of 50% fine cotton and 50% polyester. To allow optimal absorbency of the cover, this mix ratio is recommended. The pockets material is made of 100% woven polyester and reinforced with a sponge insert to support the gliding of the holder. The mop cover is ideal for use in all areas, especially in health care, due to the high quality yarn fibers (cotton, polyester, polyester microfibre). Floor coverings are cleaned hygienically and without fatigue.

PROPERTIES

The hygienic mixed yarn cover offers an above-average service life due to its special tufting process whereby the loops are firmly anchored in the cover sheet. The mop cover convinces with very good gliding properties and high dirt and water absorption.

- Optimal dirt and water absorption
- High area coverage due to optimal distribution of the individual yarns
- Very good gliding properties for fatigue-free work
- Tear-resistant and water-permeable polyester pockets
- Long service life due to high-quality manufacturing process and special yarns

APPLICATION

Can be used both dry and wet on smooth, coated and uncoated floor coverings.

APPLICATION AREA

For maintenance cleaning of any surfaces, such as elastic coverings, hard coverings, porcelain stoneware, stone floors, tiles, laminate floors and ideally suited for smooth and porous floor coverings. Particularly suitable for use in health care, clinics, retirement and nursing homes as well as public facilities and building cleaning.

WASHING RECOMMENDATION

A washing temperature of 60 °C is recommended. A maximum washing temperature of 95 °C should not be exceeded. The use of fabric softeners and bleaching agents should be avoided. In general, it is recommended to wash only unmixed fabrics. Do not exceed 80 °C when drying.



LOCUS VENTI

HYGIENE-MIXED YARN COVER

THE HYGIENE MIXED YARN COVER FOR LARGE LAUNDRIES!

MADE IN EEC

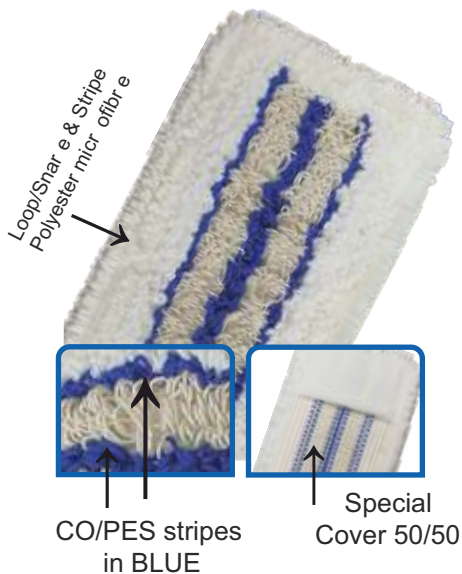

SPECIFICATIONS

Yarn mixture: 25% CO/PES yarn, NATURE
65% polyester microfibre, WHITE
10% rayon fibre, BLUE

Yarn colour: WHITE-NATURE-BLUE
Cover sheet: 50% fine cotton and 50% polyester
Edging tape: 100 % polyester, WHITE
Bag material: 100% polyester
Shrinkage value: 2-3%
Washing label: Embroidery label in WHITE, embroidered on 2 sides
4-colour coding: BLUE, GREEN, YELLOW, RED

Measurements: 40 cm 50 cm
Weight: ca. 135 g ca. 170 g

UNITS: 75 pcs. 50 pcs.
article-no.: LV40 LV50

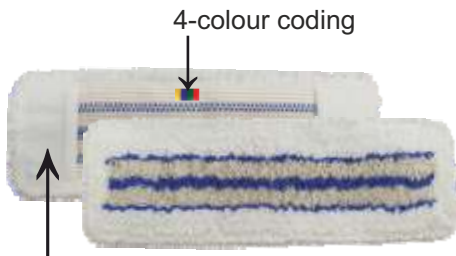

4-colour coding

Bag material made of 100% polyester with inserts tear resistant & water permeable



Do not use fabric softener
Wash according to type



SPECIAL FEATURES

The cover sheet is made of 50% cotton and 50% polyester. The bag material is made of 100% woven polyester and reinforced with a sponge insert to help the holder slide.

PROPERTIES

The hygienic mixed yarn cover offers an above-average service life due to its special tufting process, whereby the loops are firmly anchored in the cover sheet.

The mop cover convinces with very good gliding properties and high dirt and water absorption. Due to the closed outer fringes made of polyester microfibre, hygienic cleaning is achieved.

- Optimal dirt and water absorption due to loops of polyester microfibre
- High area coverage due to optimal distribution of the individual yarns
- Very good gliding properties for fatigue-free work
- Tear-resistant and water-permeable polyester pockets
- Long service life due to high-quality manufacturing process and special yarns

APPLICATION

Can be used both dry and wet on smooth, coated and uncoated floor coverings.

APPLICATION AREA

For maintenance cleaning of any surfaces, such as elastic coverings, hard coverings, porcelain stoneware, stone floors, tiles, laminate floors and ideally suited for smooth and porous floor coverings. Particularly suitable for use in health care, clinics, retirement and nursing homes as well as public facilities and building cleaning.

WASHING RECOMMENDATION

A washing temperature of 60 °C is recommended. A maximum washing temperature of 95 °C should not be exceeded. The use of fabric softeners and bleaching agents should be avoided. In general, it is recommended to wash only unmixed fabrics. Do not exceed 80 °C when drying.



DAILY VENTI

FINE COTTON COVER

THE MICROFIBRE YARN COVER
WITH HIGH FILAMENT CONTENT!

MADE IN EEC

SPECIFICATIONS

Yarn mixture:	50% cotton, 50% polyester	
Yarn colour:	NATURE	
Cover sheet:	50% fine cotton und 50% polyester	
Edging tape:	100% polyester, BLUE	
Bag material:	100% polyester	
Shrinkage value:	3-4%	
Washing label:	Embroidery label in WHITE, embroidered on 2 sides	
4-colour coding:	BLUE, GREEN, YELLOW, RED	

Measurements:	40 cm	50 cm
Weight:	ca. 160 g	ca. 200 g

UNITS:	75 pcs.	50 pcs.
article-no.:	DV40	DV50

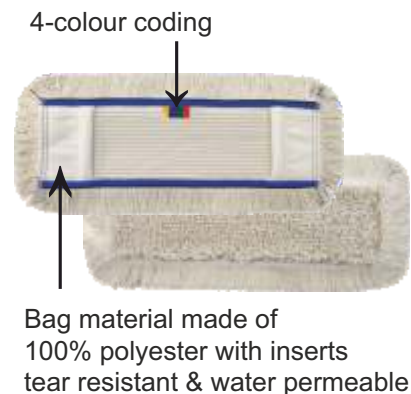

SPECIAL FEATURES

The cover is made of 50% fine cotton and 50% polyester. To allow optimal cover absorbency, this mixture ratio is recommended. Many market competitors produce this cover sheet from 100% polyester. The bag material is made of 100% woven polyester and reinforced with a sponge insert to help the holder glide.

PROPERTIES

The fine cotton cover offers an above-average service life due to its special tufting process, whereby the loops are firmly anchored in the cover sheet. The even loop distribution over the entire surface enables high dirt and water absorption as well as an ideal gliding property.

- Optimal dirt and water absorption
- High area output due to higher grammage
- Very good gliding properties for fatigue-free work
- Tear-resistant and water-permeable polyester pockets
- Long service life due to high-quality manufacturing process

APPLICATION

Can be used both dry and wet on smooth, coated and uncoated floor coverings

APPLICATION AREA

For maintenance cleaning, deep cleaning as well as wet and dry cleaning of any surfaces, such as elastic coverings, hard coverings, porcelain stoneware, stone floors, tiles, laminate floors and ideally suited for smooth floor coverings. Particularly suitable for use in industry, manufacturing, supermarkets as well as public institutions, building cleaning and health care.

WASHING RECOMMENDATION

A washing temperature of 60 °C is recommended. A maximum washing temperature of 95 °C should not be exceeded. The use of fabric softeners and bleaching agents should be avoided. In general, it is recommended to wash only unmixed fabrics. Do not exceed 80 °C when drying.



DAILY GRANDE

COTTON COVER

THE MICROFIBRE YARN COVER
WITH HIGH FILAMENT CONTENT!

MADE IN EEC

SPECIFICATIONS

Yarn mixture:	70% cotton, 30% polyester	
Yarn colour:	NATURE	
Cover sheet:	50% fine cotton and 50% polyester	
Bag material:	100% polyester, WHITE	
Bag material:	100% polyester	
Shrinkage value:	3-4%	
Washing label:	British Satin Label in WHITE, embroidered on 2 sides	

Measurements:	40 cm	50 cm
Weight:	ca. 160 g	ca. 200 g

UNITS:	75 pcs.	50 pcs.
article-no.:	DG40	DG50

SPECIAL FEATURES

The cover is made of 50% fine cotton and 50% polyester. To allow optimal cover absorbency, this mixture ratio is recommended. Many market competitors produce this cover sheet from 100% polyester. The bag material is made of 100% woven polyester and reinforced with a sponge insert to help the holder glide.

PROPERTIES

The Cotton cover offers an above-average service life due to its special tufting process, whereby the loops are firmly anchored in the cover sheet. The even loop distribution over the entire surface enables high dirt and water absorption as well as ideal gliding properties.

- Optimal dirt and water absorption
- High area output due to higher grammage
- Very good gliding properties for fatigue-free work
- Tear-resistant and water-permeable polyester pockets
- Long service life due to high-quality manufacturing process

APPLICATION

Can be used both dry and wet on smooth, coated and uncoated floor coverings

APPLICATION AREA

For maintenance cleaning, deep cleaning as well as wet and dry cleaning of any surfaces, such as elastic coverings, hard coverings, porcelain stoneware, stone floors, tiles, laminate floors and ideally suited for smooth floor coverings. Particularly suitable for use in industry, manufacturing, supermarkets as well as public facilities and building cleaning.

WASHING RECOMMENDATION

A washing temperature of 60 °C is recommended. A maximum washing temperature of 90 °C should not be exceeded. The use of fabric softeners and bleaching agents should be avoided. In general, it is recommended to wash only unmixed fabrics. Do not exceed 80 °C when drying.



Special
Cover sheet 50/50

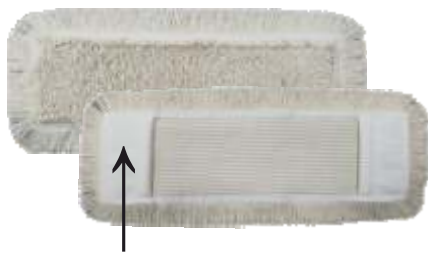

Bag material made of
100% polyester with inserts
tear resistant & water permeable



Do not use fabric softener
Wash according to type





DAILY TALL

COTTON COVER LIGHT

THE MICROFIBRE YARN COVER
WITH HIGH FILAMENT CONTENT!

MADE IN EEC

SPECIFICATIONS

Yarn mixture: 70% cotton, 30% polyester
 Yarn colour: NATURE
 Cover sheet: 50% Edelbaumwolle und 50% Polyester
 Edging tape: 100% polyester, BLUE
 Bag material: 100% polyester
 Shrinkage value: 3-4%
 Washing label: British Satin Label in WEISS, 2-seitig bedruckt

Measurements: 40 cm 50 cm
 Weight: ca. 120 g ca. 160 g

UNITS: 90 pcs. 80 pcs.
 article-no.: DT40 DT50



Special
Cover sheet 50/50

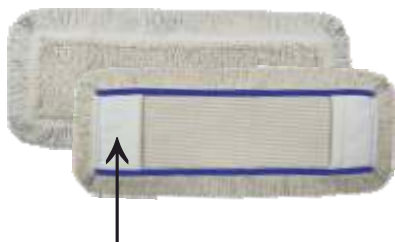

Bag material made of
100% polyester with inserts
tear resistant & water permeable



SPECIAL FEATURES

The cover is made of 50% fine cotton and 50% polyester. To allow optimal cover absorbency, this mixture ratio is recommended. Many market competitors produce this cover sheet from 100% polyester. The bag material is made of 100% woven polyester and reinforced with a sponge insert to help the holder glide.

PROPERTIES

The cotton cover Light offers an above-average service life due to its special tufting process, whereby the loops are firmly anchored in the cover sheet. The even loop distribution over the entire surface enables high dirt and water absorption as well as ideal gliding properties.

- Optimal dirt and water absorption
- The economical solution
- Very good gliding properties for fatigue-free work
- Tear-resistant and water-permeable polyester pockets
- Long service life due to high-quality manufacturing process

APPLICATION

Can be used both dry and wet on smooth, coated and uncoated floor coverings

APPLICATION AREA

For maintenance cleaning, deep cleaning as well as wet and dry cleaning of any surfaces, such as elastic coverings, hard coverings, porcelain stoneware, stone floors, tiles, laminate floors and ideally suited for smooth floor coverings. Particularly suitable for use in industry, manufacturing, supermarkets as well as public facilities and building cleaning.

WASHING RECOMMENDATION

A washing temperature of 60 °C is recommended. A maximum washing temperature of 90 °C should not be exceeded. The use of fabric softeners and bleaching agents should be avoided. In general, it is recommended to wash only unmixed fabrics. Do not exceed 80 °C when drying.



İSTANBUL



BALIKESİR/BANDIRMA



PROFESSIONAL CLEANING EQUIPMENT

PROFESYONEL TEMİZLİK EKİPMANLARI



www.staff.com.tr www.staffcleaningtrolley.com www.starmakina.com.tr

Star Teknik Servis Hizmetleri San. ve Tic. Ltd. Sti.
Ferhatpasa Mah. 34 Sok. No. 30A Atasehir Istanbul TURKIYE 34888
Fax. +90 216 471 22 02

Tel. +90 216 471 23 47 Dah./Ext.122
GSM 1. +90 549 717 49 90
GSM 2. +90 541 376 10 93
GSM 3. +90 541 331 43 99

E-Mail: star@starmakina.com.tr
satis@starmakina.com.tr
export@starmakina.com.tr